



# FAN102

## Primary-Side-Control PWM Controller

### Features

- Constant-Voltage (CV) and Constant-Current (CC) Control without Secondary-Feedback Circuitry
- Green Mode: PWM Frequency Linearly Decreasing
- Fixed PWM Frequency at 42kHz with Frequency Hopping to Solve EMI Problem
- Cable Compensation in CV Mode
- Low Startup Current: 10µA
- Low Operating Current: 3.5mA
- Peak-Current-Mode Control in CV Mode
- Cycle-by-Cycle Current Limiting
- V<sub>DD</sub> Over-Voltage Protection with Auto-Restart
- V<sub>DD</sub> Under-Voltage Lockout (UVLO)
- Gate Output Maximum Voltage Clamped at 18V
- Fixed Over-temperature Protection with Auto-Restart
- SOP-8 Package Available

### Applications

- Battery chargers for cellular phones, cordless phones, PDA, digital cameras, power tools
- Replaces linear transformer and RCC SMPS

### Description

This highly integrated PWM controller, FAN102, provides several features to enhance the performance of low-power flyback converters. The proprietary topology enables simplified circuit design for battery charger applications. A low-cost, smaller and lighter charger results when compared to a conventional design or a linear transformer. The startup current is only 10µA, which allows use of large startup resistance for further power saving.

To minimize the standby power consumption, the proprietary green-mode function provides off-time modulation to linearly decrease PWM frequency under light-load conditions. This green-mode function assists the power supply in meeting the power conservation requirements.

Using FAN102, a charger can be implemented with fewer external components and minimized cost. A typical output CV/CC characteristic envelope is shown in Figure 1.

FAN102 controller is available in 8-pin SOP package.

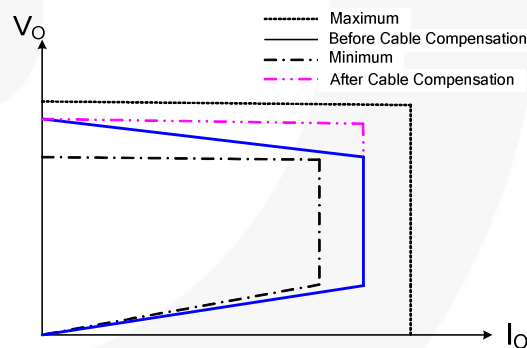

Figure 1. Typical Output V-I Characteristic

### Ordering Information

Part Number	Operating Temperature Range	Eco Status	Package	Packing Method
FAN102MY	-40°C to +105°C	Green	8-Lead, Small Outline Package (SOP-8)	Tape & Reel

For Fairchild's definition of "green" Eco Status, please visit: [http://www.fairchildsemi.com/company/green/rohs\\_green.html](http://www.fairchildsemi.com/company/green/rohs_green.html).

### Application Diagram

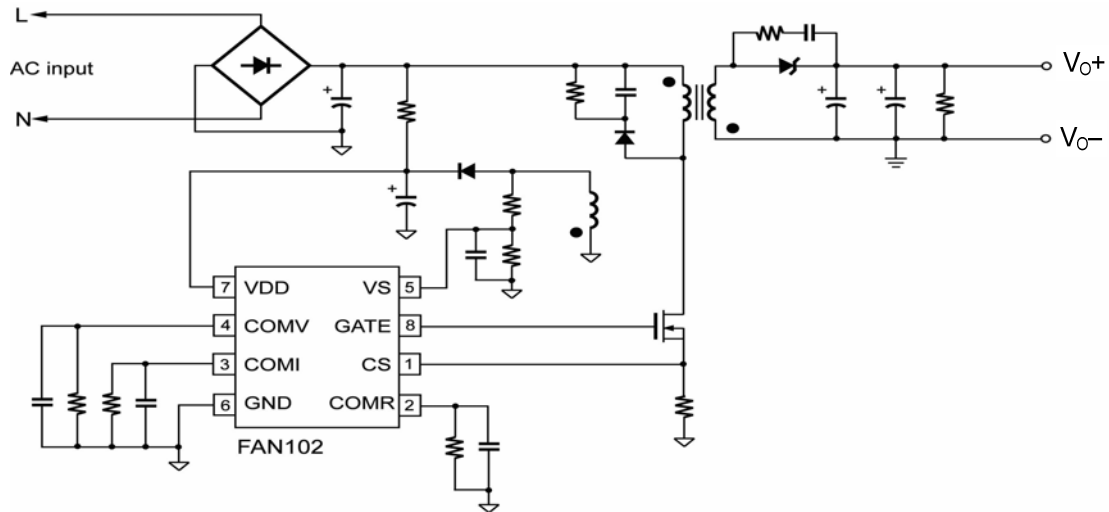

Figure 2. Typical Application

### Internal Block Diagram

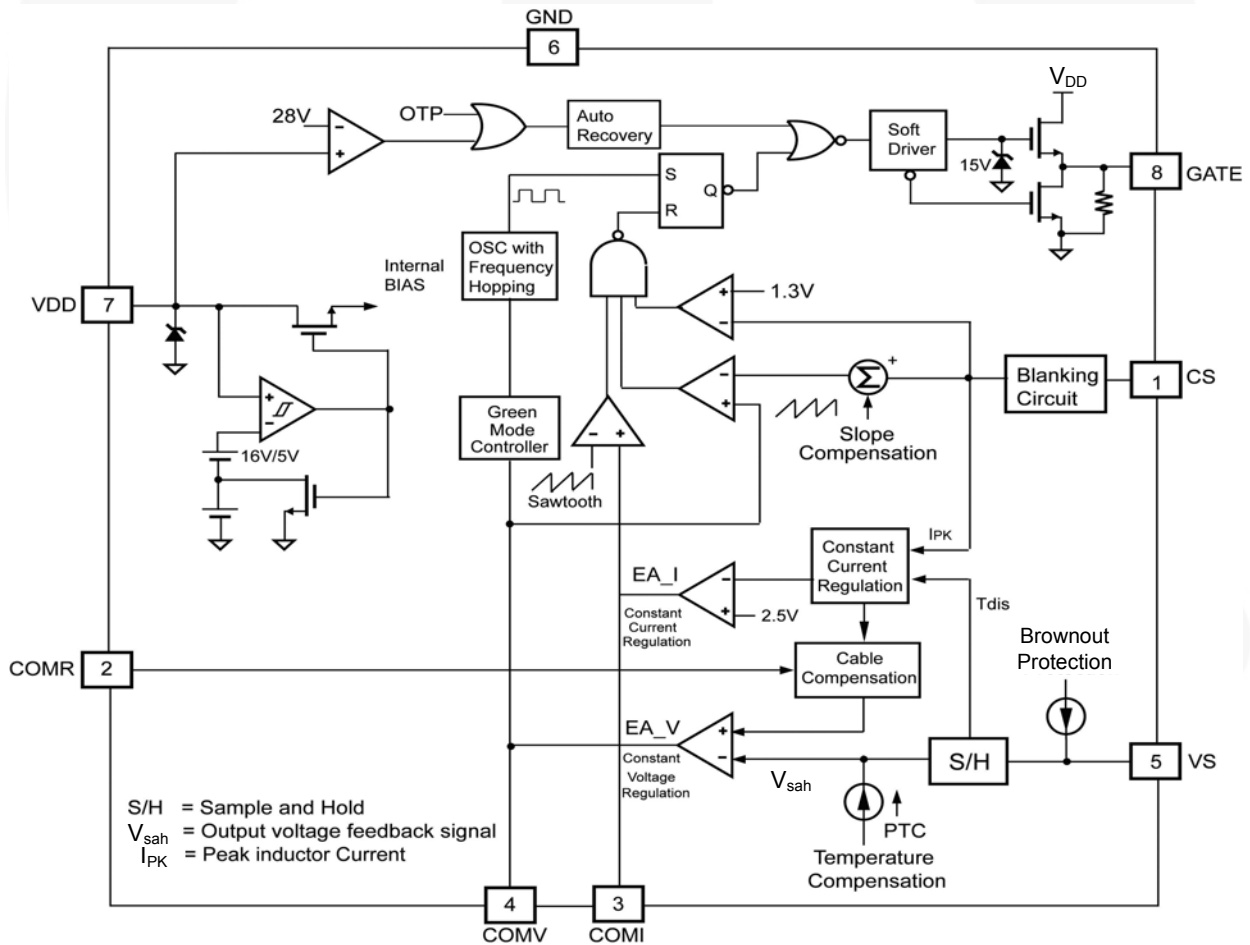
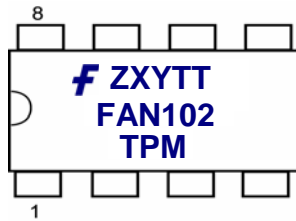

Figure 3. Functional Block Diagram

## Marking Information



F- Fairchild logo  
 Z- Plant code  
 X- 1 digit year code  
 Y- 1 digit week code  
 TT: 2 digits die run code  
 T: Package type (M=SOP)  
 P: Z: Pb free, Y: Green package  
 M: Manufacture flow code

Figure 4. Top Mark

## Pin Configuration

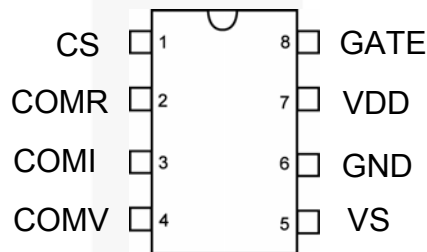

Figure 5. Pin Configuration

## Pin Definitions

Pin #	Name	Description
1	CS	Analog input, current sense. Connected to a current-sense resistor for peak-current-mode control in CV mode. The current-sense signal is also provided for output-current regulation in CC mode.
2	COMR	Analog output, cable compensation. Connect a resistor between COMR and GND for cable loss compensation in CV mode.
3	COMI	Analog output, current compensation. Output of the current error amplifier. Connect a capacitor between COMI pin and GND for frequency compensation.
4	COMV	Analog output, voltage compensation. Output of the voltage error amplifier. Connect a capacitor between the COMV pin and GND for frequency compensation.
5	VS	Analog input, voltage sense. Output-voltage-sense input for output-voltage regulation.
6	GND	Voltage reference, ground.
7	VDD	Supply, power supply.
8	GATE	Driver output. The totem-pole output driver to drive the power MOSFET.

## Absolute Maximum Ratings

Stresses exceeding the absolute maximum ratings may damage the device. The device may not function or be operable above the recommended operating conditions and stressing the parts to these levels is not recommended. In addition, extended exposure to stresses above the recommended operating conditions may affect device reliability. The absolute maximum ratings are stress ratings only.

Symbol	Parameter	Min.	Max.	Unit
V <sub>DD</sub>	DC Supply Voltage <sup>(1,2)</sup>		30	V
V <sub>VS</sub>	VS Pin Input Voltage	-0.3	7.0	V
V <sub>CS</sub>	CS Pin Input Voltage	-0.3	7.0	V
V <sub>COMV</sub>	Voltage Error Amplifier Output Voltage	-0.3	7.0	V
V <sub>COMI</sub>	Voltage Error Amplifier Output Voltage	-0.3	7.0	V
P <sub>D</sub>	Power Dissipation (T <sub>A</sub> < 50°C)		660	mW
θ <sub>JA</sub>	Thermal Resistance (Junction-to-Air)		150	°C/W
θ <sub>JC</sub>	Thermal Resistance (Junction-to-Case)		39	°C/W
T <sub>J</sub>	Operating Junction Temperature		+150	°C
T <sub>STG</sub>	Storage Temperature Range	-55	+150	°C
T <sub>L</sub>	Lead Temperature (Wave Soldering or IR, 10 Seconds)		+260	°C
ESD	Electrostatic Discharge Capability, Human Body Model, JEDEC- JESD22_A114		4.5	KV
	Electrostatic Discharge Capability, Charged Device Model, JEDEC- JESD22_C101		1250	V

### Notes:

1. Stresses beyond those listed under “absolute maximum ratings” may cause permanent damage to the device.
2. All voltage values, except differential voltages, are given with respect to GND pin.

## Recommended Operating Conditions

The Recommended Operating Conditions table defines the conditions for actual device operation. Recommended operating conditions are specified to ensure optimal performance to the datasheet specifications. Fairchild does not recommend exceeding them or designing to Absolute Maximum Ratings.

Symbol	Parameter	Conditions	Min.	Typ.	Max.	Unit
T <sub>A</sub>	Operating Ambient Temperature		-40		+105	°C

## Electrical Characteristics

$V_{DD}=15V$  and  $T_A=25^{\circ}C$  unless otherwise specified.

Symbol	Parameter	Conditions	Min.	Typ.	Max.	Units	
<b>V<sub>DD</sub> Section</b>							
$V_{OP}$	Continuously Operating Voltage				25	V	
$V_{DD-ON}$	Turn-On Threshold Voltage		15	16	17	V	
$V_{DD-OFF}$	Turn-Off Threshold Voltage		4.5	5.0	5.5	V	
$I_{DD-OP}$	Operating Current	$V_{DD}=20V$ , $f_s=f_{OSC}$ , $V_{VS}=2V$ , $V_{CS}=3V$ , $C_L=1nF$		3.5	5.0	mA	
$I_{DD-GREEN}$	Green-Mode Operating Supply Current	$V_{DD}=20V$ , $V_{VS}=2.7V$ $f_s=f_{OSC-N-MIN}$ , $V_{CS}=0V$ $C_L=1nF$ , $V_{COMV}=0V$		1	2	mA	
$V_{DD-OVP}$	$V_{DD}$ Over-Voltage Protection Level	$V_{CS}=3V$ , $V_{VS}=2.3V$	27	28	29	V	
$t_{D-VDDOVP}$	$V_{DD}$ Over-Voltage Protection Debounce Time	$f_s=f_{OSC}$ , $V_{VS}=2.3V$	100	250	400	$\mu s$	
<b>Oscillator Section</b>							
$f_{OSC}$	Frequency	Center Frequency	$T_A=25^{\circ}C$	39	42	45	KHz
		Frequency Hopping Range	$T_A=25^{\circ}C$	$\pm 1.8$	$\pm 2.6$	$\pm 3.6$	
$t_{FHR}$	Frequency Hopping Period	$T_A=25^{\circ}C$		3		ms	
$f_{OSC-N-MIN}$	Minimum Frequency at No Load	$V_{VS}=2.7V$ , $V_{COMV}=0V$		550		Hz	
$f_{OSC-CM-MIN}$	Minimum Frequency at CCM	$V_{VS}=2.3V$ , $V_{CS}=0.5V$		20		KHz	
$f_{DV}$	Frequency Variation vs. $V_{DD}$ Deviation	$V_{DD}=10V$ to $25V$			5	%	
$f_{DT}$	Frequency Variation vs. Temperature Deviation	$T_A=-40^{\circ}C$ to $+105^{\circ}C$			15	%	
<b>Voltage-Sense Section</b>							
$I_{VS-UVP}$	Sink Current for Brownout Protection	$R_{VS}=20K\Omega$		180		$\mu A$	
$I_{tc}$	IC Compensation Bias Current			9.5		$\mu A$	
$V_{BIAS-COMV}$	Adaptive Bias Voltage Dominated by $V_{COMV}$	$V_{COMV}=0V$ , $T_A=25^{\circ}C$ , $R_{VS}=20K\Omega$		1.4		V	
<b>Current-Sense Section</b>							
$t_{PD}$	Propagation Delay to GATE Output			100	200	ns	
$t_{MIN-N}$	Minimum On Time at No Load	$V_{VS}=-0.8V$ , $R_S=2K\Omega$ , $V_{COMV}=1V$		1100		ns	
$t_{MINCC}$	Minimum On Time in CC Mode	$V_{VS}=0V$ , $V_{COMV}=2V$		400		ns	
$V_{TH}$	Threshold Voltage for Current Limit			1.3		V	

Continued on the following page...

## Electrical Characteristics

$V_{DD}=15V$  and  $T_A=25^{\circ}C$  unless otherwise specified.

Symbol	Parameter	Conditions	Min.	Typ.	Max.	Units
<b>Voltage-Error-Amplifier Section</b>						
$V_{VR}$	Reference Voltage		2.475	2.500	2.525	V
$V_N$	Green Mode Starting Voltage on COMV Pin	$f_s=f_{OSC}=2KHz$ , $V_{VS}=2.3V$		2.8		V
$V_G$	Green Mode Ending Voltage on COMV Pin	$f_s=1KHz$		0.8		V
$I_{V-SINK}$	Output Sink Current	$V_{VS}=3V$ , $V_{COMV}=2.5V$		90		$\mu A$
$I_{V-SOURCE}$	Output Source Current	$V_{VS}=2V$ , $V_{COMV}=2.5V$		90		$\mu A$
$V_{V-HGH}$	Output High Voltage	$V_{VS}=2.3V$	4.5			V
<b>Current-Error-Amplifier Section</b>						
$V_{IR}$	Reference Voltage		2.475	2.500	2.525	V
$I_{I-SINK}$	Output Sink Current	$V_{CS}=3V$ , $V_{COMI}=2.5V$		55		$\mu A$
$I_{I-SOURCE}$	Output Source Current	$V_{CS}=0V$ , $V_{COMI}=2.5V$		55		$\mu A$
$V_{I-HGH}$	Output High Voltage	$V_{CS}=0V$	4.5			V
<b>Cable Compensation Section</b>						
$V_{COMR}$	Variation Test Voltage on COMR Pin for Cable Compensation	$R_{COMR}=100K\Omega$		0.735		V
<b>Gate Section</b>						
$DCY_{MAX}$	Maximum Duty Cycle			75		%
$V_{OL}$	Output Voltage Low	$V_{DD}=20V$ , $I_O=10mA$			1.5	V
$V_{OH}$	Output Voltage High	$V_{DD}=8V$ , $I_O=1mA$	5			V
$V_{OH\_MIN}$	Output Voltage High	$V_{DD}=5.5V$ , $I_O=1mA$	4			V
$t_r$	Rising Time	$V_{DD}=20V$ , $C_L=1nF$		200	300	ns
$t_f$	Falling Time	$V_{DD}=20V$ , $C_L=1nF$		80	150	ns
$V_{CLAMP}$	Output Clamp Voltage	$V_{DD}=25V$		15	18	V
<b>Over-Temperature-Protection Section</b>						
$T_{OTP}$	Threshold Temperature for OTP <sup>(3)</sup>			+140		$^{\circ}C$

### Note:

- When over-temperature protection is activated, the power system enters auto restart mode and output is disabled.

### Typical Performance Characteristics

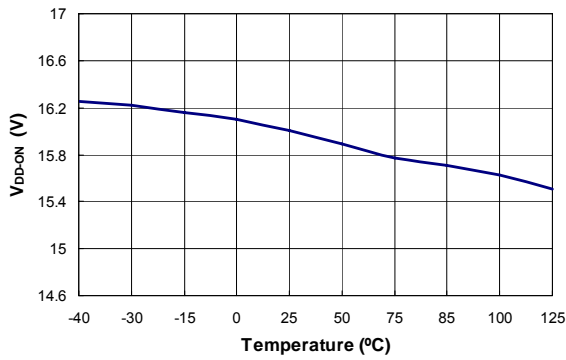

Figure 6. Turn-on Threshold Voltage (V<sub>DD-ON</sub>) vs. Temperature

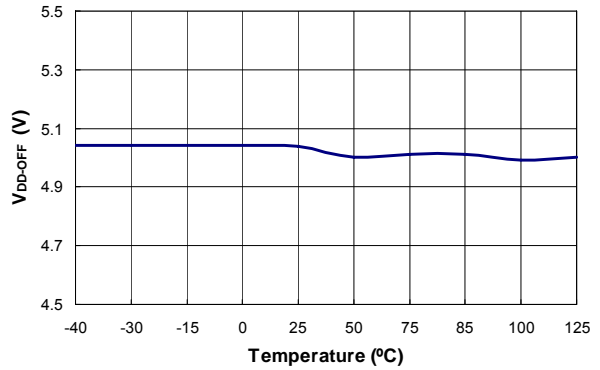

Figure 7. Turn-off Threshold Voltage (V<sub>DD-OFF</sub>) vs. Temperature

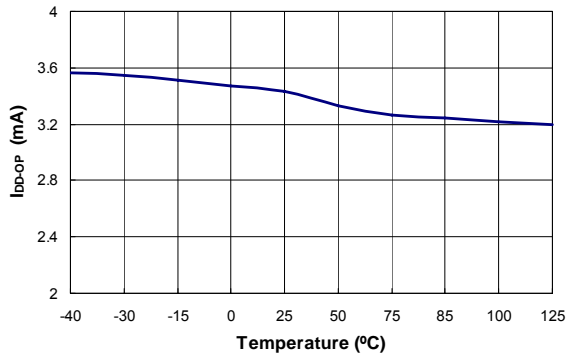

Figure 8. Operating Current (I<sub>DD-OP</sub>) vs. Temperature

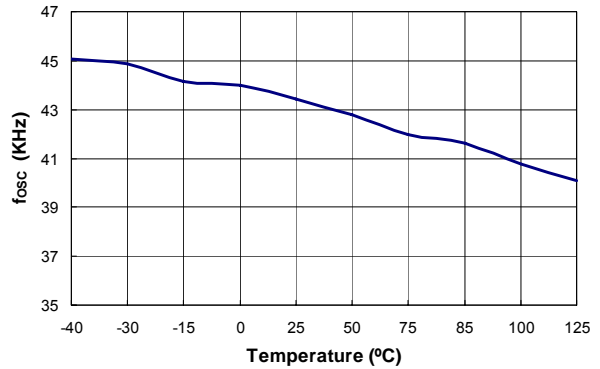

Figure 9. Center Frequency (f<sub>osc</sub>) vs. Temperature

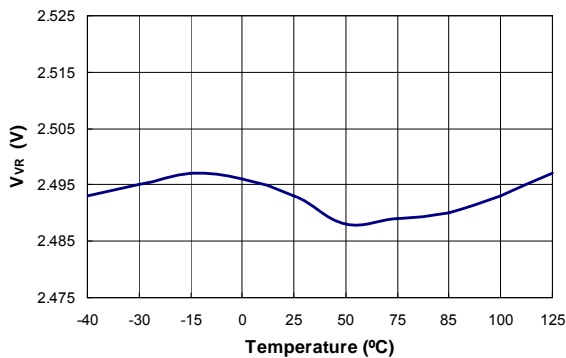

Figure 10. Reference Voltage (V<sub>VR</sub>) vs. Temperature

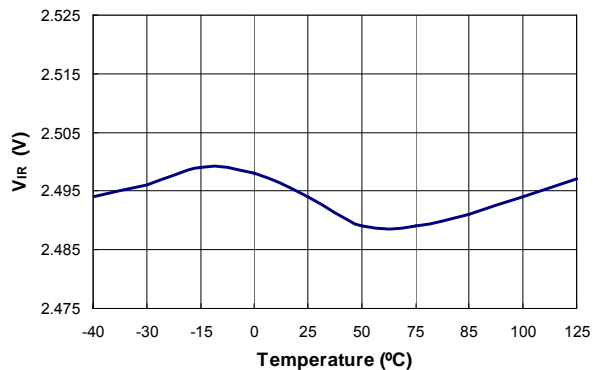

Figure 11. Reference Voltage (V<sub>IR</sub>) vs. Temperature

### Typical Performance Characteristics

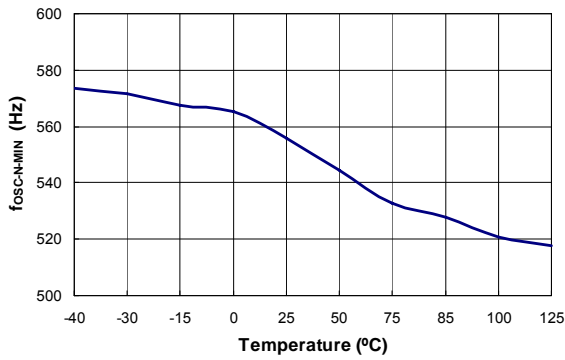

Figure 12. Minimum Frequency at No Load (f<sub>OSC-N-MIN</sub>) vs. Temperature

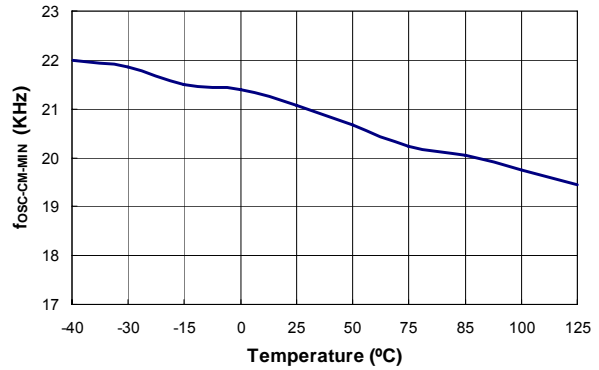

Figure 13. Minimum Frequency at CCM (f<sub>OSC-CM-MIN</sub>) vs. Temperature

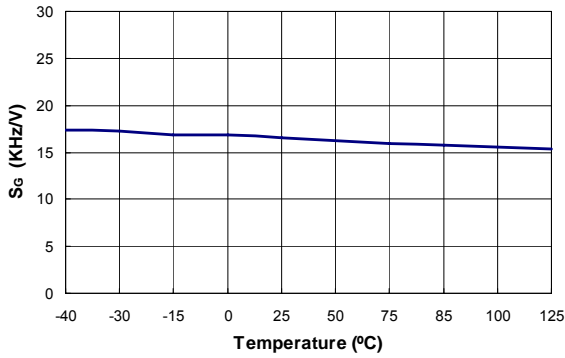

Figure 14. Green Mode Frequency Decreasing Rate (S<sub>G</sub>) vs. Temperature

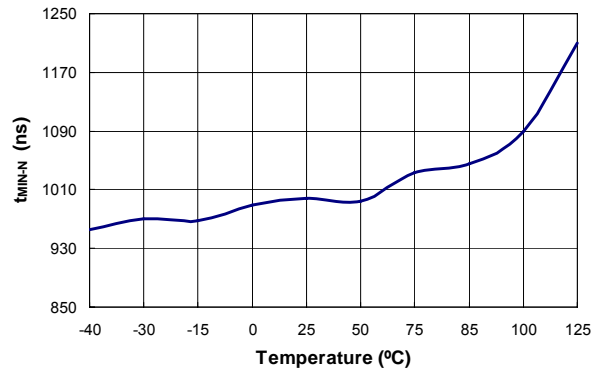

Figure 15. Minimum On Time at No Load (t<sub>MIN-N</sub>) vs. Temperature

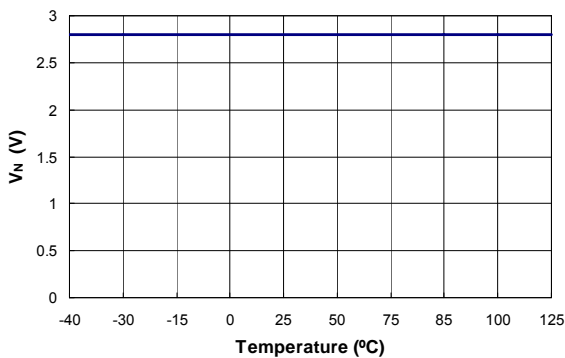

Figure 16. Green Mode Starting Voltage on COMV Pin (V<sub>N</sub>) vs. Temperature

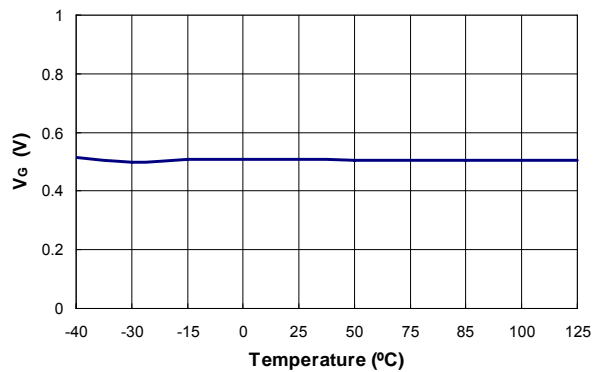
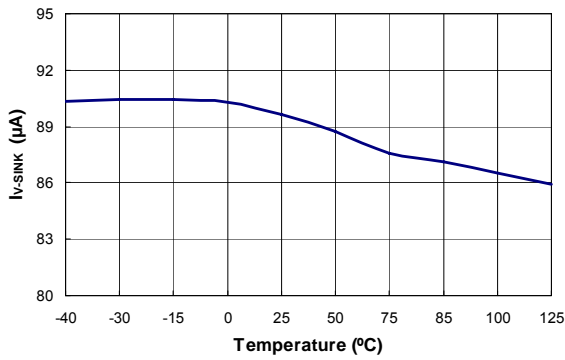

Figure 17. Green Mode Ending Voltage on COMV Pin (V<sub>G</sub>) vs. Temperature



## Typical Performance Characteristics



**Figure 18. Output Sink Current ( $I_{V-SINK}$ ) vs. Temperature**

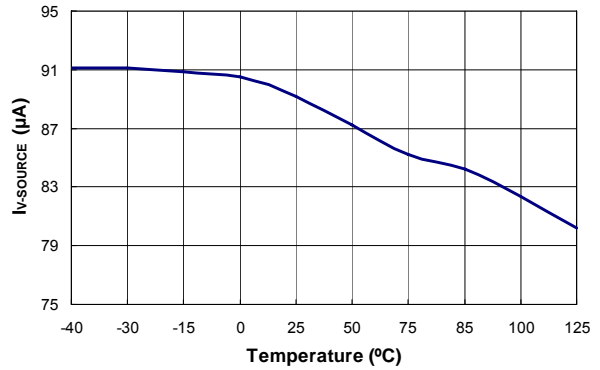

**Figure 19. Output Source Current ( $I_{V-SOURCE}$ ) vs. Temperature**

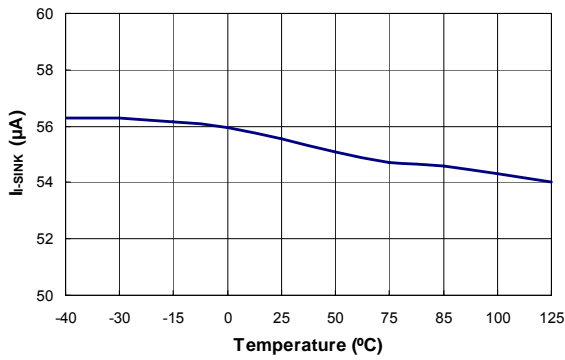

**Figure 20. Output Sink Current ( $I_{I-SINK}$ ) vs. Temperature**

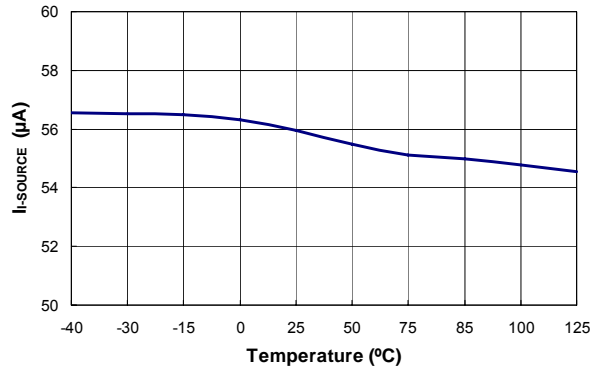

**Figure 21. Output Source Current ( $I_{I-SOURCE}$ ) vs. Temperature**

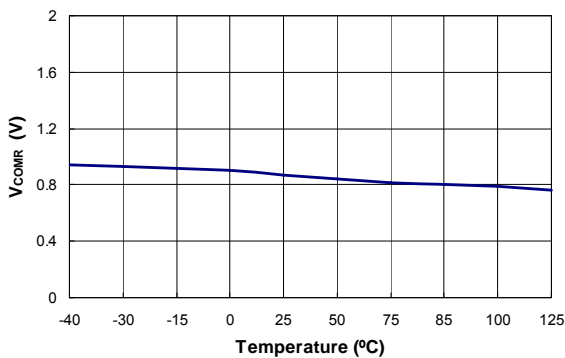

**Figure 22. Variation Test Voltage on COMR Pin for Cable Compensation ( $V_{COMR}$ ) vs. Temperature**

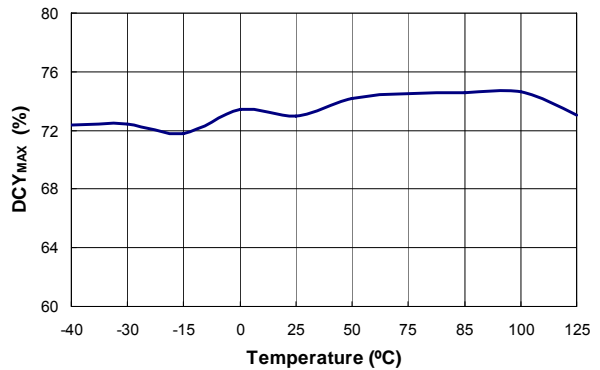

**Figure 23. Maximum Duty Cycle ( $DCY_{MAX}$ ) vs. Temperature**

## Functional Description

The proprietary topology of FAN102 enables most simplified circuit design for battery charger applications. Without secondary feedback circuitry, the CV and CC control are achieved accurately. As shown in Figure 24, with the frequency-hopping PWM operation, EMI problems can be solved by using minimized filter components. FAN102 also provides many protection functions. The VDD pin is equipped with over-voltage protection and under-voltage lockout. Pulse-by-pulse current limiting and CC control ensure over-current protection at heavy loads. The GATE output is clamped at 15V to protect the external MOSFET from over-voltage damage. Also, the internal over-temperature-protection function shuts down the controller with latch when overheated.

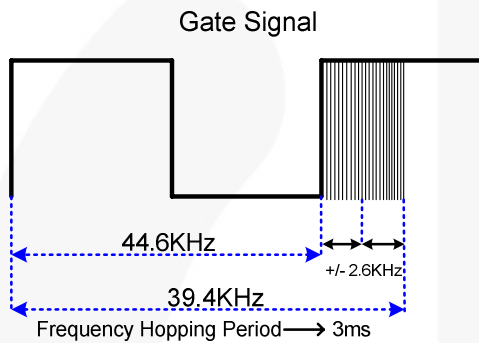

Figure 24. Frequency Hopping

### Startup Current

The startup current is 10 $\mu$ A. Low startup current allows a startup resistor with a high resistance and a low-wattage to supply the startup power for the controller. A 1.5M $\Omega$ , 0.25W, startup resistor and a 10 $\mu$ F/25V V<sub>DD</sub> hold-up capacitor are sufficient for an AC-to-DC power adapter with a wide input range (100V<sub>AC</sub> to 240V<sub>AC</sub>).

### Operating Current

The operating current has been reduced to 3.5mA. The low operating current results in higher efficiency and reduces the V<sub>DD</sub> hold-up capacitance requirement. Once FAN102 enters “deep” green mode, the operating current is reduced to 1.2mA, which assists the power supply in meeting the power conservation requirements.

### Green-Mode Operation

Figure 25 shows the characteristics of the PWM frequency vs. the output voltage of the error amplifier (V<sub>COMV</sub>). The FAN102 uses the positive, proportional, output load parameter (V<sub>COMV</sub>) as an indication of the output load for modulating the PWM frequency. In heavy load conditions, the PWM frequency is fixed at 42KHz. Once V<sub>COMV</sub> is lower than V<sub>N</sub>, the PWM frequency starts to linearly decrease from 42KHz to 550Hz, providing further power savings and meeting international power conservation requirements.

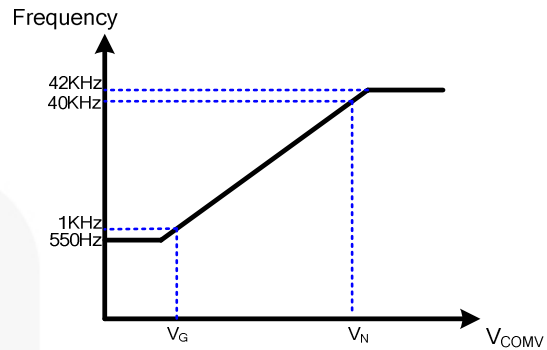

Figure 25. Green Mode Frequency vs. V<sub>COMV</sub>

### Constant Voltage (CV) and Constant Current (CC) Operation

An innovative technique allows the FAN102 to accurately achieve CV / CC characteristic output without secondary-side voltage or current-feedback circuitry. A feedback signal for CV / CC operation from the reflected voltage across the primary auxiliary winding is proportional to secondary winding, so provides the controller the feedback signal from secondary side and achieves constant voltage output property. In constant-current-output operation, this voltage signal is detected and examined by the precise constant current regulation controller, which then determines the on-time of the MOSFET to control input power and provide constant current output property. With feedback voltage V<sub>CS</sub> across the current-sense resistor, the controller can obtain input power of power supply. Therefore, the region of constant current output operation can be adjusted by the current-sense resistor.

### Temperature Compensation

Built-in temperature compensation provides better constant voltage regulation at different ambient temperatures. This internal compensation current is a positive temperature coefficient (PTC) current that can compensate the forward-voltage drop of the secondary diode of varying with temperature. This variation causes output voltage rising at high temperature.

### Leading-Edge Blanking (LEB)

Each time the power MOSFET switches on, a turn-on spike occurs at the sense resistor. To avoid premature termination of the switching pulse, a leading-edge blanking time is built in. Conventional RC filtering can be omitted. During this blanking period, the current-limit comparator is disabled and cannot switch off the gate driver.

## Functional Description (Continued)

### Under-Voltage Lockout (UVLO)

The turn-on and turn-off thresholds are fixed internally at 16V and 5V. During startup, the hold-up capacitor must be charged to 16V through the startup resistor to enable the FAN102. The hold-up capacitor continues to supply  $V_{DD}$  until power can be delivered from the auxiliary winding of the main transformer.  $V_{DD}$  must not drop below 5V during this startup process. This UVLO hysteresis window ensures that hold-up capacitor is adequate to supply  $V_{DD}$  during startup.

### $V_{DD}$ Over-Voltage Protection (OVP)

$V_{DD}$  over-voltage protection prevents damage due to over-voltage conditions. When the  $V_{DD}$  voltage exceeds 28V due to abnormal conditions, PWM pulses are disabled until the  $V_{DD}$  voltage drops below the UVLO, then start again. Over-voltage conditions are usually caused by open feedback loops.

### Over-Temperature Protection (OTP)

The built-in temperature-sensing circuit shuts down PWM output once the junction temperature exceeds 140°C. While PWM output is shut down, the  $V_{DD}$  voltage gradually drops to the UVLO voltage. Some of the FAN102's internal circuits are shut down and  $V_{DD}$  gradually starts increasing again. When  $V_{DD}$  reaches 16V, all the internal circuits, including the temperature-sensing circuit, start operating normally. If the junction temperature is still higher than 140°C, the PWM controller shuts down immediately.

### Gate Output

The BiCMOS output stage is a fast totem-pole gate driver. Cross conduction has been avoided to minimize heat dissipation, increase efficiency, and enhance reliability. The output driver is clamped by an internal 15V Zener diode to protect power MOSFET transistors against undesired over-voltage gate signals.

### Built-in Slope Compensation

The sensed voltage across the current-sense resistor is used for current-mode control and pulse-by-pulse current limiting. Built-in slope compensation improves stability and prevents sub-harmonic oscillations due to peak-current mode control. The FAN102 has a synchronized, positively-sloped ramp built-in at each switching cycle.

### Noise Immunity

Noise from the current sense or the control signal can cause significant pulse-width jitter, particularly in continuous-conduction mode. While slope compensation helps alleviate these problems, further precautions should still be taken. Good placement and layout practices should be followed. Avoiding long PCB traces and component leads, locating compensation and filter components near the FAN102, and increasing the power MOS gate resistance are advised.

### Applications Information

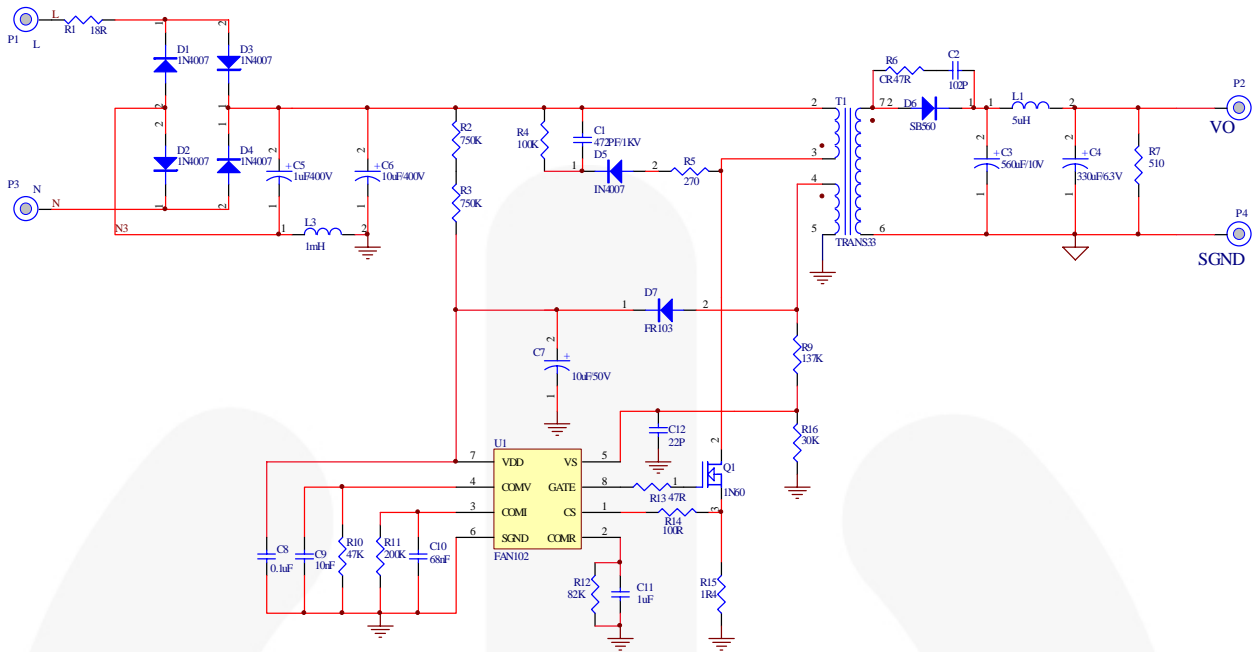

Figure 26. 5W (5V/1A) Application Circuit

### BOM

Designator	Part Type	Designator	Part Type
D1, D2, D3, D4, D5	1N4007	R4	R 100KΩ
D6	SB560	R5	R 270Ω
D7	FR103	R6	R 47Ω
C1	CC 4.7nF/1KV	R7	R 510Ω
C2	1nF	R9	R 137KΩ
C3	EC 560μF/10V	R10	R 47KΩ
C4	EC 330μF/6.3V	R11	R 200KΩ
C5	EC 1μF/400V	R12	R 82KΩ
C6	EC 10μF/400V	R13	R 47Ω
C7	EC 10μF/50V	R14	R 100Ω
C8	0.1μF	R15	R 1.4Ω
C9	10nF	R16	R 30KΩ
C10	68nF	L1	5μH
C11	1μF	L3	1mH
C12	22pF	Q1	MOSFET 1A/600V
R1	R 18Ω	T1	EE16 (1.5mH)
R2, R3	R 750KΩ	U1	IC FAN102

### Physical Dimensions

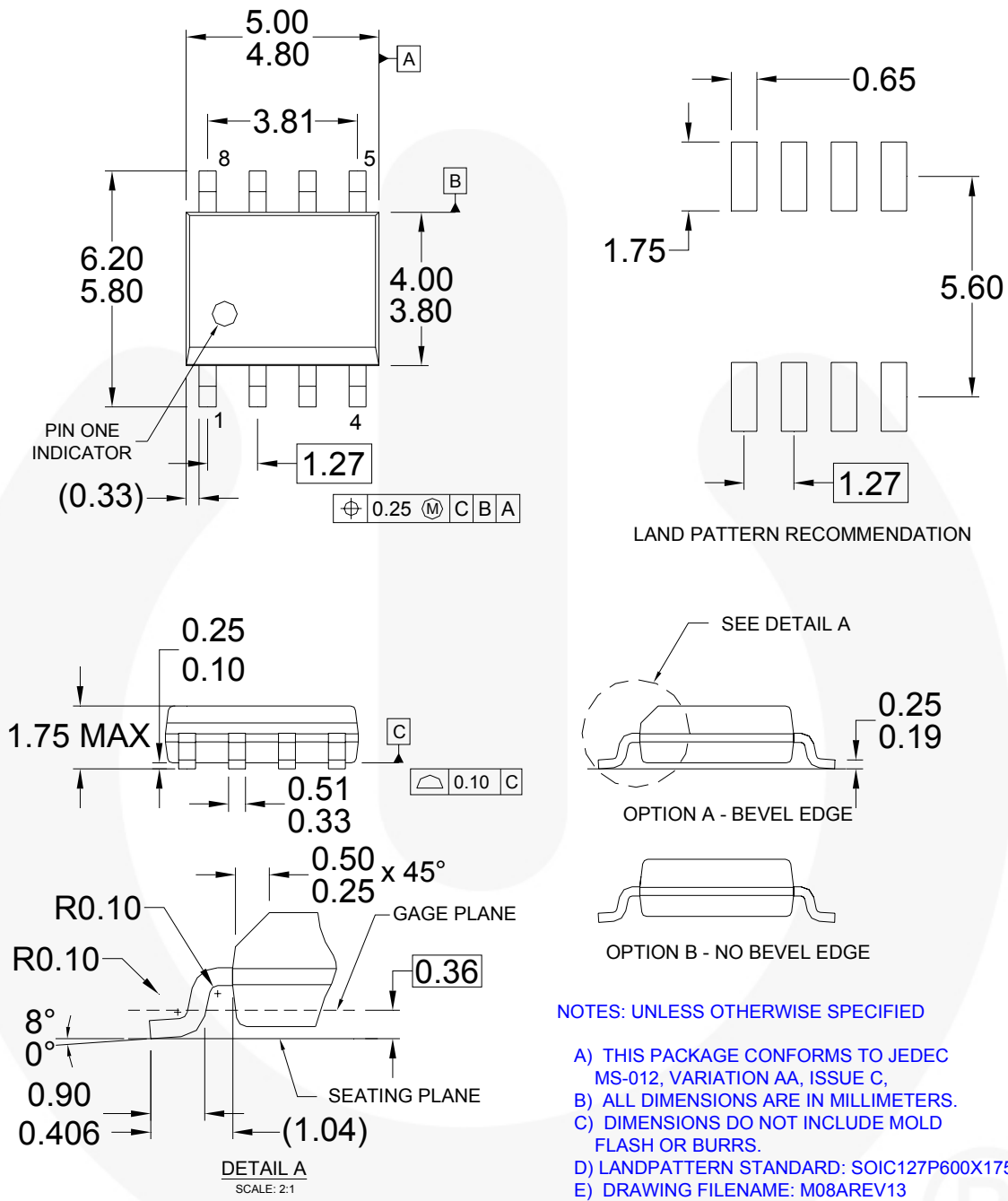

Figure 27. 8-Lead, Small Outline Package (SOP-8)



Package drawings are provided as a service to customers considering Fairchild components. Drawings may change in any manner without notice. Please note the revision and/or date on the drawing and contact a Fairchild Semiconductor representative to verify or obtain the most recent revision. Package specifications do not expand the terms of Fairchild's worldwide terms and conditions, specifically the warranty therein, which covers Fairchild products.

Always visit Fairchild Semiconductor's online packaging area for the most recent package drawings:  
<http://www.fairchildsemi.com/packaging/>.



**TRADEMARKS**

The following includes registered and unregistered trademarks and service marks, owned by Fairchild Semiconductor and/or its global subsidiaries, and is not intended to be an exhaustive list of all such trademarks.

- |   |   |   |   |
|---|---|---|---|
| Build it Now™   | FRFET®  | Programmable Active Droop™  |  |
| CorePLUS™   | Global Power Resource <sup>SM</sup>   | QFET®   | TinyBoost™  |
| CorePOWER™  | Green FPST™   | QST™  | TinyBuck™   |
| CROSSVOLT™  | Green FPST™ e-Series™   | Quiet Series™   | TinyLogic®  |
| CTL™  | GTO™  | RapidConfigure™   | TINYOPTO™   |
| Current Transfer Logic™   | IntelliMAX™   |  | TinyPower™  |
| EcoSPARK®   | ISOPLANAR™  | Saving our world, 1mW/W/kW at a time™   | TinyPWM™  |
| EfficientMax™   | MegaBuck™   | SmartMax™   | TinyWire™   |
| EZSWITCH™ *   | MICROCOUPLER™   | SMART START™  | µSerDes™  |
|  | MicroFET™   | SPM®  |  |
|  | MicroPak™   | STEALTH™  | UHC®  |
| Fairchild®  | MillerDrive™  | SuperFET™   | Ultra FRFET™  |
| Fairchild Semiconductor®  | MotionMax™  | SuperSOT™.3   | UniFET™   |
| FACT Quiet Series™  | Motion-SPM™   | SuperSOT™.6   | VCM™  |
| FACT®   | OPTOLOGIC®  | SuperSOT™.8   | VisualMax™  |
| FAST®   | OPTOPLANAR®   | SupreMOS™   | XST™  |
| FastvCore™  |  | SyncFET™  |   |
| FlashWriter® *  | PDP SPM™  |  |   |
| FPST™   | Power-SPM™  | The Power Franchise®  |   |
| F-PFST™   | PowerTrench®  |   |   |
|   | PowerXS™  |   |   |

\* EZSWITCH™ and FlashWriter® are trademarks of System General Corporation, used under license by Fairchild Semiconductor.

**DISCLAIMER**

FAIRCHILD SEMICONDUCTOR RESERVES THE RIGHT TO MAKE CHANGES WITHOUT FURTHER NOTICE TO ANY PRODUCTS HEREIN TO IMPROVE RELIABILITY, FUNCTION, OR DESIGN. FAIRCHILD DOES NOT ASSUME ANY LIABILITY ARISING OUT OF THE APPLICATION OR USE OF ANY PRODUCT OR CIRCUIT DESCRIBED HEREIN; NEITHER DOES IT CONVEY ANY LICENSE UNDER ITS PATENT RIGHTS, NOR THE RIGHTS OF OTHERS. THESE SPECIFICATIONS DO NOT EXPAND THE TERMS OF FAIRCHILD'S WORLDWIDE TERMS AND CONDITIONS, SPECIFICALLY THE WARRANTY THEREIN, WHICH COVERS THESE PRODUCTS.

**LIFE SUPPORT POLICY**

FAIRCHILD'S PRODUCTS ARE NOT AUTHORIZED FOR USE AS CRITICAL COMPONENTS IN LIFE SUPPORT DEVICES OR SYSTEMS WITHOUT THE EXPRESS WRITTEN APPROVAL OF FAIRCHILD SEMICONDUCTOR CORPORATION.

As used herein:

1. Life support devices or systems are devices or systems which, (a) are intended for surgical implant into the body or (b) support or sustain life, and (c) whose failure to perform when properly used in accordance with instructions for use provided in the labeling, can be reasonably expected to result in a significant injury of the user.
2. A critical component in any component of a life support, device, or system whose failure to perform can be reasonably expected to cause the failure of the life support device or system, or to affect its safety or effectiveness.

**ANTI-COUNTERFEITING POLICY**

Fairchild Semiconductor Corporation's Anti-Counterfeiting Policy. Fairchild's Anti-Counterfeiting Policy is also stated on our external website, [www.fairchildsemi.com](http://www.fairchildsemi.com), under Sales Support.

Counterfeiting of semiconductor parts is a growing problem in the industry. All manufacturers of semiconductor products are experiencing counterfeiting of their parts. Customers who inadvertently purchase counterfeit parts experience many problems such as loss of brand reputation, substandard performance, failed applications, and increased cost of production and manufacturing delays. Fairchild is taking strong measures to protect ourselves and our customers from the proliferation of counterfeit parts. Fairchild strongly encourages customers to purchase Fairchild parts either directly from Fairchild or from Authorized Fairchild Distributors who are listed by country on our web page cited above. Products customers buy either from Fairchild directly or from Authorized Fairchild Distributors are genuine parts, have full traceability, meet Fairchild's quality standards for handling and storage and provide access to Fairchild's full range of up-to-date technical and product information. Fairchild and our Authorized Distributors will stand behind all warranties and will appropriately address any warranty issues that may arise. Fairchild will not provide any warranty coverage or other assistance for parts bought from Unauthorized Sources. Fairchild is committed to combat this global problem and encourage our customers to do their part in stopping this practice by buying direct or from authorized distributors.

**PRODUCT STATUS DEFINITIONS**

**Definition of Terms**

Datasheet Identification	Product Status	Definition
Advance Information	Formative / In Design	Datasheet contains the design specifications for product development. Specifications may change in any manner without notice.
Preliminary	First Production	Datasheet contains preliminary data; supplementary data will be published at a later date. Fairchild Semiconductor reserves the right to make changes at any time without notice to improve design.
No Identification Needed	Full Production	Datasheet contains final specifications. Fairchild Semiconductor reserves the right to make changes at any time without notice to improve the design.
Obsolete	Not In Production	Datasheet contains specifications on a product that is discontinued by Fairchild Semiconductor. The datasheet is for reference information only.

Rev. I37